

SINCE 1991



GROUP OF COMPANIES

# GOVARDHAN GEAR NAXON DRIVE SYSTEM

F SERIES HELICAL GEARBOX



NAXON

*G*  
GEAR'S

*A Name You Can Trust*

# Dimensions of Outline Installation

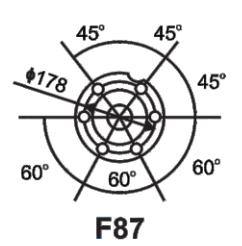
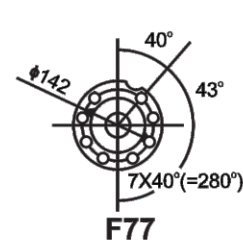
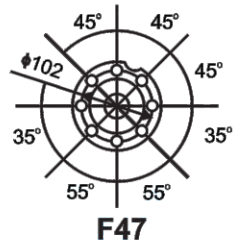
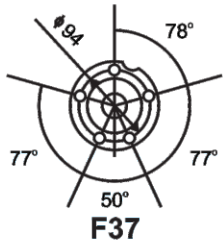
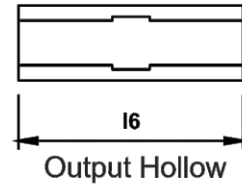
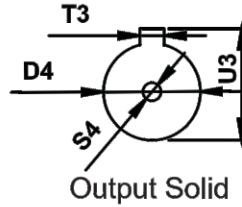
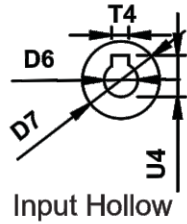
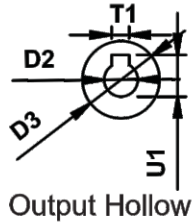
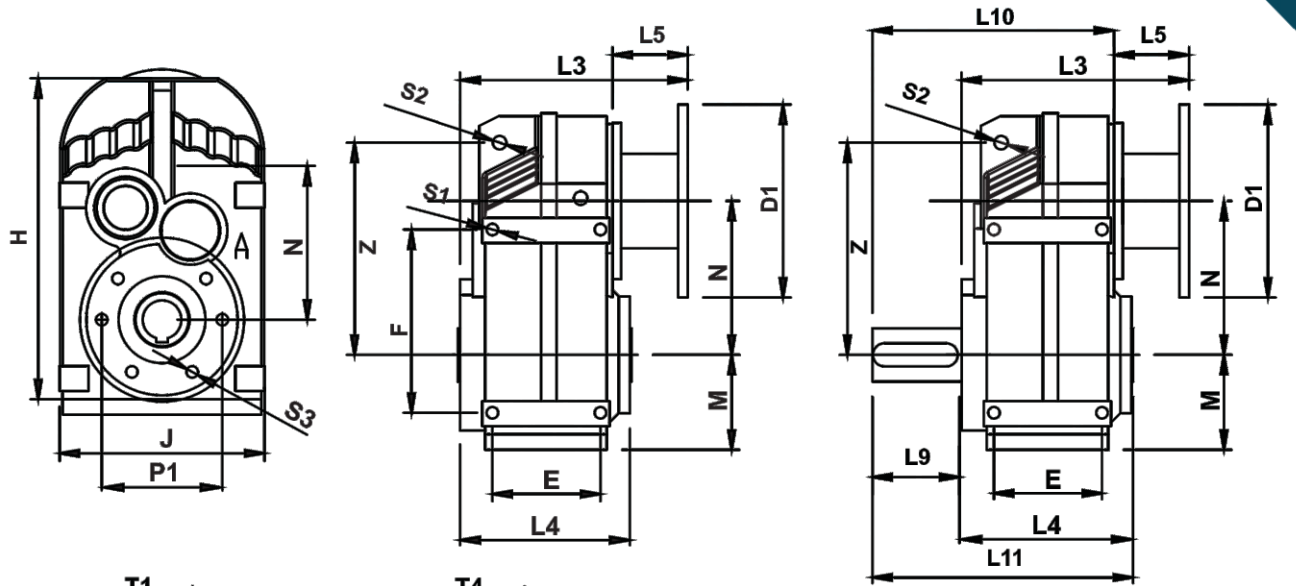

Size	A	D3	D1	S1	L4	Z	M	F	L5	T1	S3	L10	L9	D4	T3	D6	T4
	B	D2	I6	S2	L3	H	N	E	J	U1	P1	L11		S4	U3	D7	U4
F-37	130	30	160	M8	120	158.5	47.5	115	77	8	M8	165	50	25	8	14	5
	200	50	128	14	192	240	112	77	180	33.3	94	170		M10	28	35	16.5
F-47	130	35	200	M10	146	168.5	69.2	145	78	10	M8	190	60	25	8	19	6
	200	50	150	14	208	265	129	93	180	38.3	102	206		M10	28	35	22
F-57	180	40	200	M12	160	223.5	81.3	190	81	12	M12	206	70	35	10	24	8
	250	50	165	14	217	303	137.8	112	204	43.3	125	230		M12	38	40	28
F-67	180	40	250	M12	176	230.5	87	190	81	12	M12	237	80	40	12	28	8
	250	50	175	14	238	336	149.7	112	118	43.3	125	256		M16	43	45	32
F-77	230	50	300	M16	205	279.5	112	140	93	14	M12	287	100	50	14	38	10
	300	70	210	22	280	425	202.3	120	278	54.5	142	305		M16	54	65	42
F87	250	60	350	16	235	346	246.7	310	120	18	M16	340	120	60	18	42	14
	350	85	240	22	340	355	246.7	165	330	64.5	178	355		M20	64	65	46



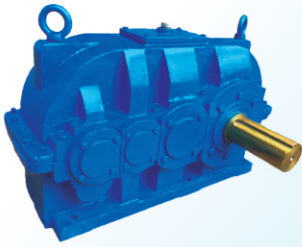

**PARALLEL  
SHAFT HELICAL**

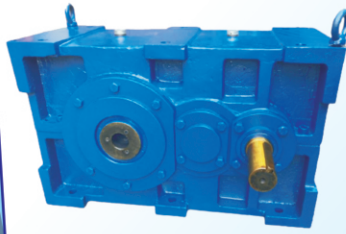

**PARALLEL HELICAL  
GEAR BOX**

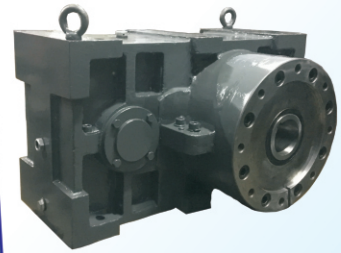

**EXTRUDER  
HELICAL GEAR BOX**



**NXU SERIES**

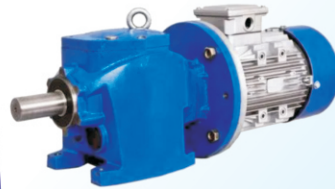

**INLINE  
HELICAL**



**INLINE HELICAL  
GEAR BOX**



**WPA WORM  
GEARBOX**



**PLENTRY  
GEAR BOX**



**NMRV  
GEAR BOX**

## **MANUFACTURERS OF : HELICAL & WORM REDUCTION GEAR BOX**

Mobile : (O) +91 94266 07917, 94266 47917, 94293 47917 || Website : [www.naxon.in](http://www.naxon.in)  
E-mail : [govardhan\\_gear@yahoo.in](mailto:govardhan_gear@yahoo.in), [govardhan.gear@gmail.com](mailto:govardhan.gear@gmail.com), [sales.naxon@gmail.com](mailto:sales.naxon@gmail.com)

42/1, Parmeshwar Ind. Estate-2, Nr. NEO Plast, Opp. HDFC Bank,  
Phase-1, GIDC, Vatva, Ahmedabad-382445.